

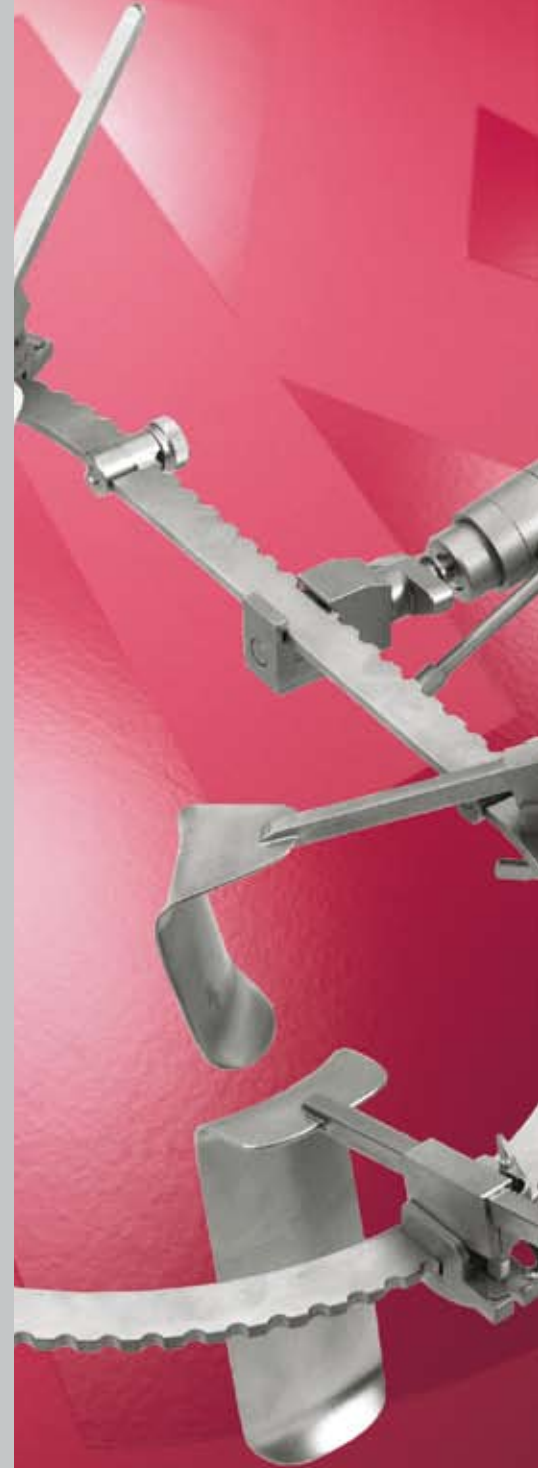

SURGERY

Retraktor Systeme
Retractor Systems

Systèmes des écarteurs
Sistemas de retractores
Sistemi di retrattori



Kataloge
Catalogues

Catalogues
Catálogos
Cataloghi

Endoskopie
Endoscopy

Endoscopia
Endoscopia
Endoscopia



Geräte
Units
Appareils
Equipos
Apparecchi

ENDOSCOPY

No. 205



Sinuskopie
Sinuscopy
Sinuscopie
Sinuscopia
Sinuscopia

ENDOSCOPY

No. 211



Optiken
Scopes
Optiques
Ópticas
Ottiche

ENDOSCOPY

No. 206



Elektro Chirurgie
Electro Surgery
Eléctrochirurgie
Electro-Cirurgia
Elettrobisturi

ENDOSCOPY

No. 212

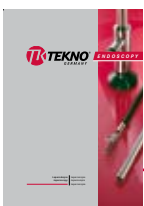

Laparoskopie
Laparoscopy
Laparoscopie
Laparoscopia
Laparoscopia

ENDOSCOPY

No. 207



Mini & Mikro System für MIC
Mini & micro system for MIS
Système mini & mikro pour MIC
Sistema mini y micro para MIC
Sistema mini e micro per MIC

ENDOSCOPY

No. 213



Urologie
Urology
Urologie
Urología
Urologia

ENDOSCOPY

No. 208

Sterilisation
Sterilization

Stérilisation
Esterilización
Sterilizzazione



Gynäkologie
Gynaecology
Gynécologie
Ginecología
Ginecologia

ENDOSCOPY

No. 209



Steril Container - System I
Steril Container - system I

Contenaires pour stérilisation - système I
Contenedores para esterilización - sistema I
Container per sterilizzazione - sistema I

SURGERY

No. 302



Arthroskopie
Arthroscopy
Arthroscopie
Artroscopia
Artroscopia

ENDOSCOPY

No. 210



Steril Container - System II
Steril Container - system II

Contenaires pour stérilisation - système II
Contenedores para esterilización - sistema II
Container per sterilizzazione - sistema II

SURGERY

No. 303

Kataloge
Catalogues

Catalogues
Catálogos
Cataloghi

Chirurgie
Surgery

Chirurgie
Cirugía
Chirurgia

Dental
Dental

Dentaire
Dental
Dentale



Hauptkatalog Chirurgie
Main catalogue surgery

Catalogue général
Catálogo general
Catalogo generale

SURGERY

No. 111



Dental
Dental

Dentaire
Dental
Dentale

DENTAL

No. 402



Plastische Chirurgie
Plastic Surgery

Chirurgie plastique
Cirugía plástica
Chirurgia plastica

SURGERY

No. 112



Ophthalmologie
Ophthalmology

Ophthalmologie
Oftalmologia
Oftalmologia

SURGERY

No. 113



Traumatologie
Traumatology

Traumatologie
Traumatología
Traumatologia

SURGERY

No. 114



Retraktor Systeme
Retractor systems

Systèmes des écarteurs
Sistema de retractores
Sistemi di retrattori

SURGERY

No. 133

Das System
The system

Le système
Il sistema
Il sistema

The **TEKNO** Medical Multiple Retractor Set has been designed to provide the flexibility necessary for the Operating Room. With almost twenty different ring possibilities and hundreds of retractor blade styles to choose from the **TEKNO** retractor system is suited for use in many different specialties and can be configured to fit the special needs of almost any patient.

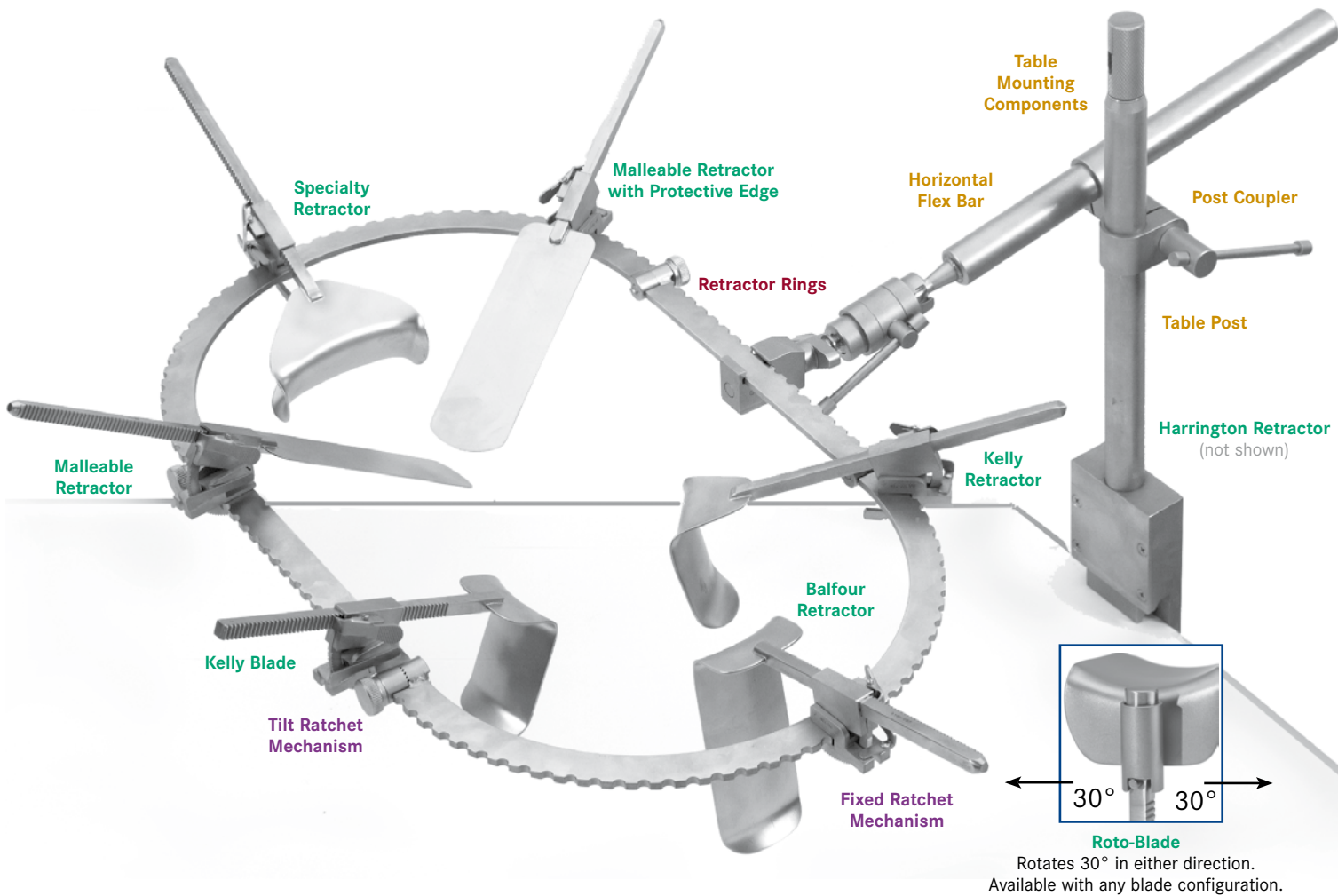

CONTENT

RINGS	Page 7
TABLE MOUNTING COMPONENTS	Page 7
RETRACTOR BLADES	Page 8 - 11
RETRACTOR SETS	Page 12 - 14
STERILIZATION SUPPLIES	Page 15

Komponenten Components	Composants Componentes Componenti
---	--

RINGS

Round Ring, Small	21 cm I.D.	tk 17920-01
Round Ring, Medium	27 cm I.D.	tk 17920-02
Round Ring, Large	32 cm I.D.	tk 17920-03
Oval Ring, Small	34 x 21 cm I.D.	tk 17920-04
Oval Ring, Medium	37 x 27 cm I.D.	tk 17920-05
Oval Ring, Large	47 x 30 cm I.D.	tk 17920-06
Segmented Ring, Medium	49 x 27 cm I.D.	tk 17920-07
Segmented Ring, Oval, Large	30 x 15 cm I.D.	tk 17920-08
Segmented Ring, Oval, Medium	25 x 20 cm I.D.	tk 17920-09
Segmented Ring, Oval, Small	20 x 10 cm I.D.	tk 17920-10
Segmented Ring, Round, Large	30 cm I.D.	tk 17920-11
Segmented Ring, Round, Medium	25 cm I.D.	tk 17920-12
Segmented Ring, Round, Small	20 cm I.D.	tk 17920-13
Vaginal Retractor Ring	20 x 26 cm I.D.	tk 17920-14
J.-Simpson Ring, Segm., slotted	21 cm I.D.	tk 17920-15
Straight Segmented/Extension	10 cm (2pcs)	tk 17920-16
Straight Segmented/Extension	15 cm (2pcs)	tk 17920-17
Straight Segmented/Extension	20 cm (2pcs)	tk 17920-18

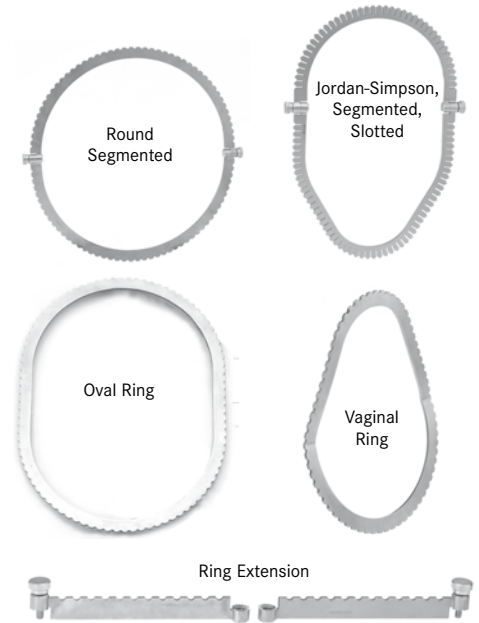
TABLE MOUNTING COMPONENTS

2.6 cm Post Coupler	tk 17921-01
Table Post, Length: 46 cm	tk 17921-02
Table Post, Length: 61 cm	tk 17921-03
Extension Bar 30.5 cm	tk 17921-04
Horizontal Bar	tk 17921-05
Horizontal Flex Bar	tk 17921-06

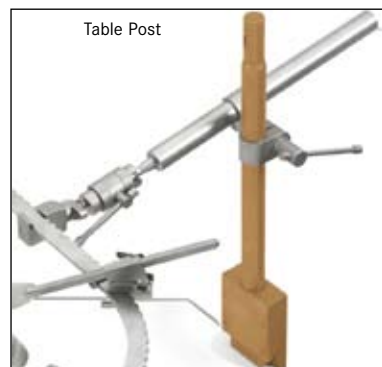
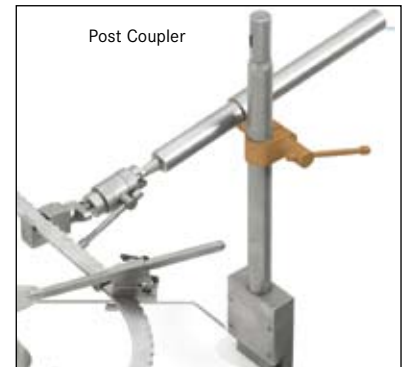

**Komponenten
Components**
**Composants
Componentes
Componenti**
RATCHET

Fixed Ratchet Mechanism	tk 17921-07
Tilt Ratchet Mechanism	tk 17921-08

Fixed Ratchet Mechanism
Allows extension or retraction along the horizontal axis at 2 mm intervals.

Tilt Ratchet Mechanism
Allows extension or retraction along the horizontal axis and allows vertical movement of retractor blade with a second ratchet.

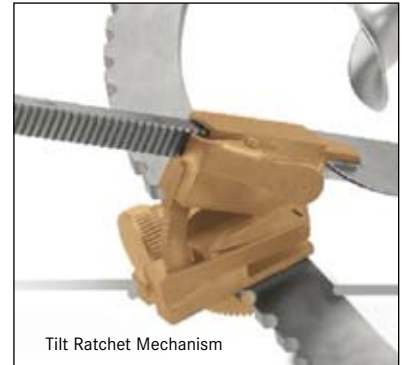
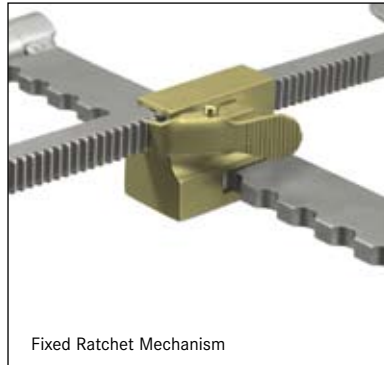
**KELLY RETRACTOR
BLADES**

3 x 4 cm	tk 17922-01
5 x 7.5 cm	tk 17922-02
5 x 10 cm	tk 17922-03
5 x 12.5 cm	tk 17922-04
7.5 x 6 cm	tk 17922-05
5 x 15 cm	tk 17922-06
6.5 x 7.5 cm	tk 17922-07
2.5 x 6 cm	tk 17922-08
2.5 x 18 cm	tk 17922-09
6 x 7.5 cm	tk 17922-10
5 x 5 cm	tk 17922-11
6 x 18 cm	tk 17922-12
6 x 20 cm	tk 17922-13
5 x 20 cm	tk 17922-14
6 x 25 cm	tk 17922-15

Width x Length

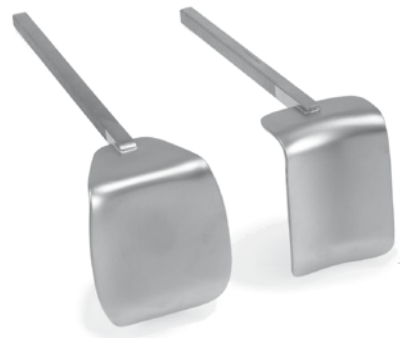
**J.-R.-SIMPSON
RETRACTOR BLADES**

2 x 2.5 cm	tk 17922-16
2 x 5 cm	tk 17922-17
2.5 x 3 cm	tk 17922-18

Width x Length



! Add **R** to any blade for rotatable

Komponenten
Components
Composants
Componentes
Componenti
**MALLEABLE
RETRACTORS**

5 x 15 cm	tk 17923-01
4 x 15 cm	tk 17923-02
7.5 x 15 cm	tk 17923-03
4 x 10 cm	tk 17923-04
4 x 7.5 cm	tk 17923-05
2.5 x 10 cm	tk 17923-06
2.5 x 12.5 cm	tk 17923-07
2.5 x 15 cm	tk 17923-08
15 x 30.5 cm	tk 17923-09
2.5 x 23 cm	tk 17923-10
5 x 18 cm	tk 17923-11
7.5 x 18 cm	tk 17923-12
5 x 23 cm	tk 17923-13
5 x 25 cm	tk 17923-14
5 x 30.5 cm	tk 17923-15
7.5 x 25 cm	tk 17923-16
7.5 x 23 cm	tk 17923-17
7.5 x 30.5 cm	tk 17923-18
10 x 25 cm	tk 17923-19
10 x 23 cm	tk 17923-20
10 x 25 cm	tk 17923-21
15 x 30.5 cm	tk 17923-22
1.5 x 7.5 cm	tk 17923-23

Width x Length

**LOUGHLIN-SIMPSON
RETRACTORS**

3.5cm x 10 cm	tk 17923-24
3.5cm x 13 cm	tk 17923-25
3.5cm x 15 cm	tk 17923-26

Width x Length

**HARRINGTON
RETRACTOR BLADES**

6 x 13.5 cm	tk 17924-01
6 x 23 cm	tk 17924-02
6 x 25 cm	tk 17924-03

Width x Length

BABY H.R. BLADES

4 x 13 cm	tk 17924-04
-----------	--------------------

Width x Length

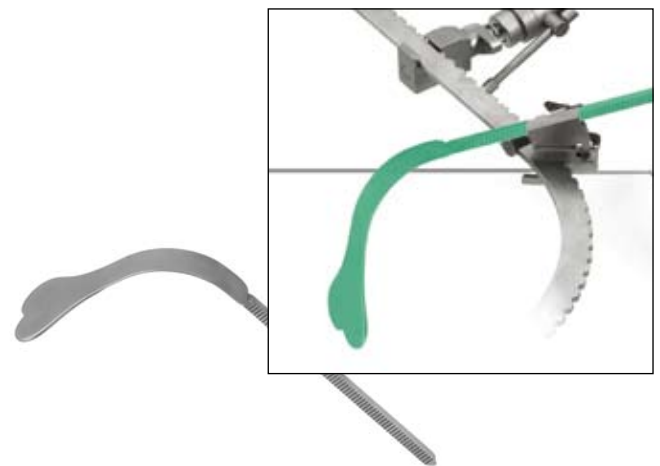
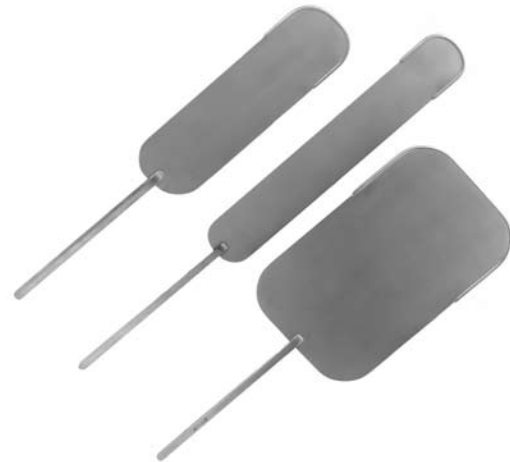
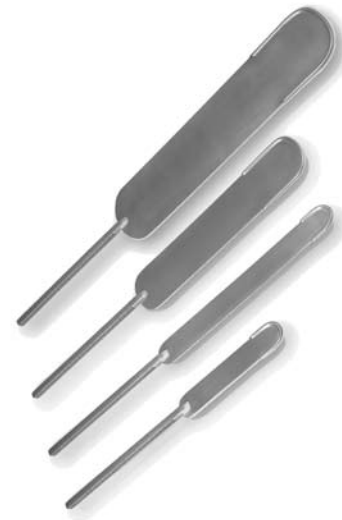
 Add **R** to any blade
for rotatable

Komponenten
Components
Composants
Componentes
Componenti
**BALFOUR
RETRACTOR BLADES**

8.5 x 10 cm	tk 17925-01
8.5 x 7 cm	tk 17925-02
8.5 x 4 cm	tk 17925-03
8.5 x 10 cm	tk 17925-04
10 x 9 cm	tk 17925-05

Width x Length

**GOULET-SIMPSON
RETRACTOR BLADES**

10 x 9.5 cm - small 2.6 cm	tk 17925-06
10 x 9.5 cm - large 3.8 cm	tk 17925-07

Width x Length



**DEAVER
RETRACTOR BLADES**

2.5 x 9 cm - small	tk 17925-08
2.5 x 18 cm - large	tk 17925-09
2.5 x 12.5 cm - large	tk 17925-10
5 x 12.5 cm - large	tk 17925-11

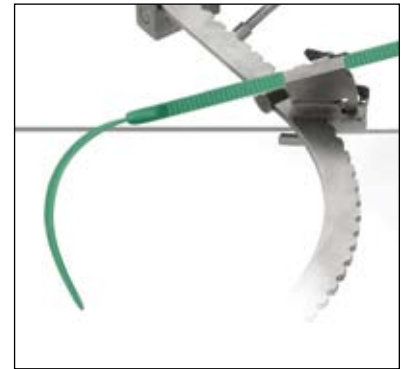
Width x Length

**LIVER
RETRACTOR**

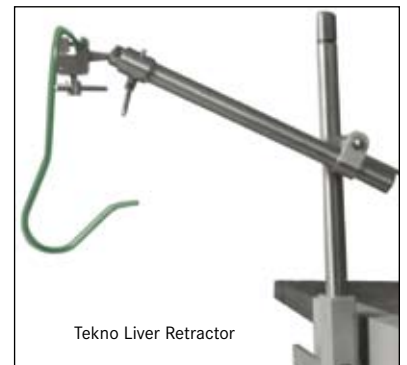
	3 mm	5 mm
small	tk 17926-01	tk 17926-04
medium	tk 17926-02	tk 17926-05
large	tk 17926-03	tk 17926-06



Tekno Liver Retractor

 Add **R** to any blade
for rotatable

**Komponenten
Components**
**Composants
Componentes
Componenti**
**GENERAL SURGERY &
DEEP PELVIC RETRACTORS**

Gelpi Retractor		tk 17927-01
Simpson-St. Mark's Retractor	12.5 cm w/ Lip	tk 17927-02
Simpson-St. Mark's Retractor	15 cm w/ Lip	tk 17927-03
Simpson-St. Mark's Retractor	18 cm w/ Lip	tk 17927-04
Simpson-St. Mark's Retractor	23 cm w/ Lip	tk 17927-05
Segmented Ring, Oval, Large	23 cm w/ Lip - Angled 15°	tk 17927-06
Simpson-Wylie Vein Retractor	2.5 x 12.5 cm	tk 17927-07
Simpson-Wylie Vein Retractor	2.5 x 15 cm	tk 17927-08
Simpson-Wylie Vein Retractor	2.5 x 18 cm	tk 17927-09
Simpson-Wylie Vein Retractor	2.5 x 23 cm	tk 17927-10
Simpson-Wylie Radiolucent Vein Retractor	2.5 x 12.5 cm	tk 17927-11
Simpson-Wylie Aluminum Radiolucent Vein Retractor	2.5 x 15 cm	tk 17927-12
Simpson-Wylie Aluminum Radiolucent Vein Retractor	2.5 x 18 cm	tk 17927-13
Simpson-Wylie Aluminum Radiolucent Vein Retractor	2.5 x 23 cm	tk 17927-14
Simpson-Murphy Gall Bladder Retractor	5 cm wide	tk 17927-15

SPECIALLY UROLOGICAL RETRACTOR BLADES

Yu-Holtgrewe Retractor, malleable	6 x 18 cm	tk 17928-01
Carroll Prostatic Retractor	4cm wide spreads to 8cm x 18cm	tk 17928-02
Single Hook Retractor, malleable	with ball probe	tk 17928-03
Double Hook Retractor, malleable	0.8 cm with ball probe	tk 17928-04

with Simpson Handle



Yu-Holtgrewe Retractor

**Add R to any blade
for rotatable**

Retraktor Sätze
Retractor sets

 Jeux des écarteurs
 Inegos de retractores
 Set di retrattori

BASIC RETRACTOR SET (tk 17930-00)

Table Post	Table Post, 2.6cm, Length: 46cm	tk 17921-02
Horizontal Flex Bar		tk 17921-06
Horizontal Bar		tk 17921-05
Post Coupling	2.6 cm	tk 17921-01
Medium Oval Ring	37 x 27 cm I.D.	tk 17920-05
Segmented Ring	49 x 27 cm I.D.	tk 17920-07
Ratchet Mechanisms (2 pcs)		tk 17921-07
Tilt Ratchet Mechanisms (6 pcs)		tk 17921-08
Kelly Retractors (2 pcs)	5 x 7.5 cm	tk 17922-02
Kelly Retractors	5 x 10 cm	tk 17922-03
Kelly Retractor	5 x 12.5 cm	tk 17922-04
Kelly Retractor	5 x 15 cm	tk 17922-06
Balfour Retractor	8.5 x 7 cm	tk 17925-02
Malleable Retractor	4 x 15 cm	tk 17923-02
Malleable Retractors (2 pcs)	5 x 15 cm	tk 17923-01
Malleable Retractor	7.5 x 15 cm	tk 17923-03
Harrington Retractor	6 x 13.5 cm	tk 17924-01
Gelpi Retractor		tk 17927-01

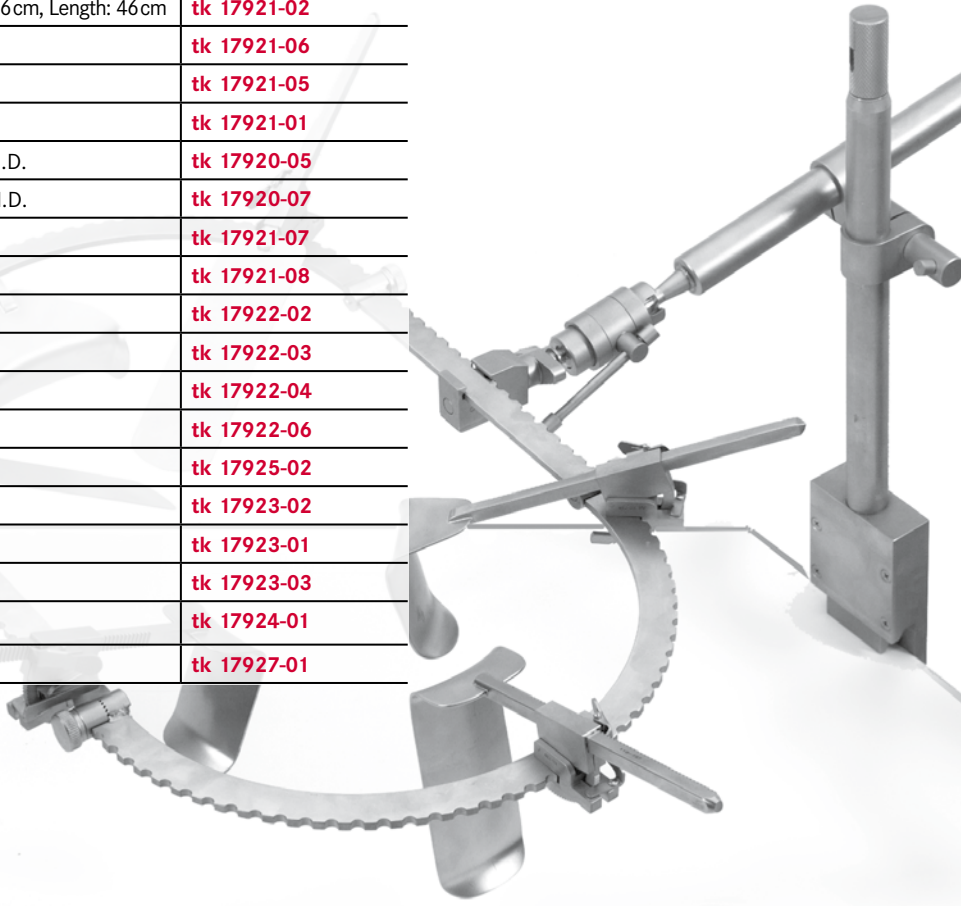
RECTAL RETRACTOR SET (tk 17935-00)

Rectal Ring	Round, 21.5cm I.D., Slotted	tk 17920-19
Rectal Blade	Fenestrated, 7.0cm, Angled	tk 17925-12
Rectal Blade	Solid, 7 cm, Angled, with Teeth	tk 17925-13

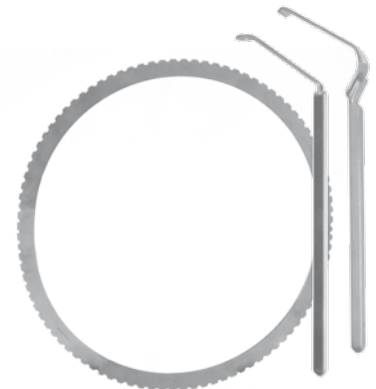

Retraktor Sätze
Retractor sets

 Jeux des écarteurs
 Juegos de retractores
 Set di retrattori

VAGINAL RETRACTOR SET (tk 17940-00)

Vaginal Retractor Ring	20 x 26cm I.D.	tk 17920-14
Posterior Blade	2.5 x 11.5cm	tk 17925-14
Lateral Retractor Blade	2.5 x 7.5cm (2pcs)	tk 17925-15
Deaver Blade	2.5 x 9.0cm - small	tk 17925-08
Deaver Blade	2.5 x 12.5cm - large	tk 17925-10



OTHER BLADES USEFUL FOR VAGINAL SURGERY (tk 17945-00)

Malleable Retractor	2.5 x 12.5 cm	tk 17923-07
Malleable Retractor	2.5 x 15 cm	tk 17923-08
Malleable Retractor	1.5 x 7.5 cm	tk 17923-23
Malleable Retractor	2.5 x 10 cm	tk 17923-06
Malleable Retractor	4.0 x 10 cm	tk 17923-04

with protective edge

Single Hook Malleable Retractor	with Ball Probe	tk 17928-03
Double Hook Malleable Retractor	8mm, with Ball Probe	tk 17928-04

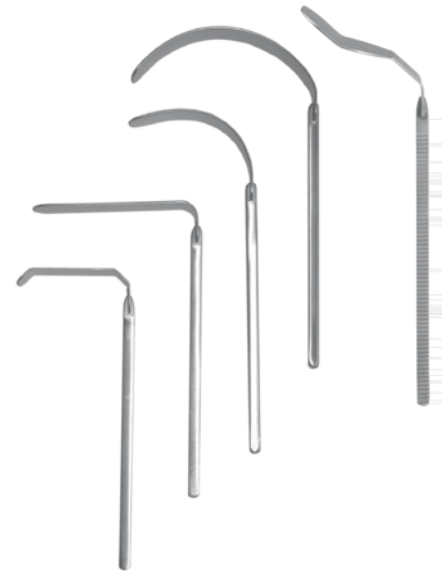
with Simpson Handle

JORDAN SIMPSON PERINEAL RETRACTOR SET (tk 17950-00)

Jordan-Simpson Segmented Retractor Ring	21 cm I.D. Slotted	tk 17920-15
Jordan-Simpson 3 Prong Retractor	Rotational Handle (2 pcs)	tk 17925-16
Jordan-Simpson 4 Prong Retractor	Rotational Handle (2 pcs)	tk 17925-17
Jordan-Simpson Right Angled Retractor	2.5 cm, 90°	tk 17925-18
Jordan-Simpson Right Angled Retractor	4 cm, 90°	tk 17925-19
Jordan-Richardson-Simpson Retractor	2.5 x 4 cm	tk 17925-20
Goulet-Simpson Retractor	10 x 9.5 cm - small 2.6 cm	tk 17925-06

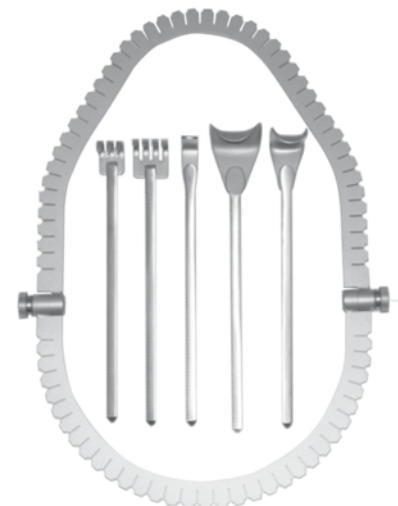

Retraktor Sätze
Retractor sets

 Jeux des écarteurs
 Inegos de retractores
 Set di retrattori

WALTHER SIMPSON PERINEAL RETRACTOR SET (tk 17955-00)

Jordan-Simpson Segmented Retractor Ring	21 cm I.D., slotted	tk 17920-15
Malleable Retractor	2.5 x 10 cm w/ Protective Edge (2 pcs)	tk 17923-06
Malleable Retractor	4 x 10 cm w/ Protective Edge	tk 17923-04
Walther-Simpson Notched Retractor	4 x 10 cm	tk 17928-05



BARIATRIC RETRACTOR SET (tk 17960-00)

Table Post	Length: 46 cm	tk 17921-02
Horizontal Bar		tk 17921-05
Post Coupling		tk 17921-01
Horizontal Flex Bar		tk 17921-06
Medium Oval Ring	37 x 27 cm I.D.	tk 17920-05
Vertical Extension Bar	30.5 cm	tk 17921-04
Malleable Retractor	5 x 25 cm w/ Prot. Edge	tk 17923-14
Malleable Retractor	7,5 x 25 cm w/ Prot. Edge	tk 17923-16
Malleable Retractor	10 x 25 cm w/ Prot. Edge	tk 17923-21
Kelly Retractor	5 x 7.5 cm	tk 17922-02
Kelly Retractor	5 x 10 cm	tk 17922-03
Kelly Retractor	5 x 20 cm	tk 17922-14
Balfour Blade Retractor	10 x 9 cm	tk 17925-05
Harrington Retractor	6 x 25 cm	tk 17924-03

Optional:

Exchange 61 cm table post (tk 17921-03) for 46 cm table post (tk 17921-02)

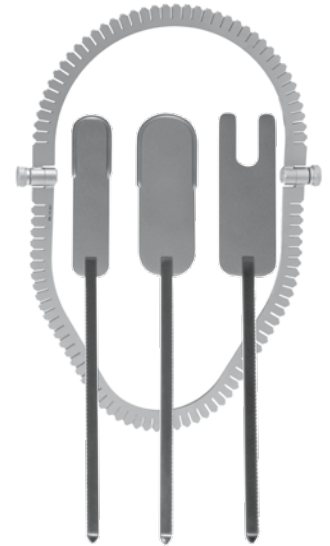
Container und Zubehör
Containers and accessories

Contenaires et accessoires
Contenedores y accesorios
Container et accessori

Lid and bottom perforated with filter



580 x 280 x 260 mm

tk 87100-2F-SI

Without safety lid

580 x 280 x 260 mm

tk 87110-2F-SI

With safety lid

540 x 250 x 100 mm

tk 87015-04

Wire mesh basket, stainless



1 pc

tk 87021-00

Long term textile filter



100 pcs

tk 87020-00

Single use paper filter



4 pcs

tk 87002-00

Screwable basket feet for use with containers with perforated bottom

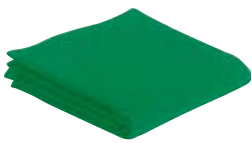

1850 x 450 mm

tk 87026-09

Drape

1850 x 600 mm

tk 87026-10

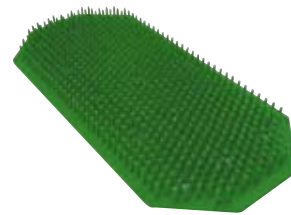

520 x 230 mm

tk 87027-06

Silicon mat



545 x 255 mm

tk 87023-03

Drape retainer

Notizen	Notices
<i>Notes</i>	<i>Notas</i>
	Note

Nummernverzeichnis
Numerical Index
Index numériques
Indice numerico
Indice dei numeri d'articolo

Art. No.	Page	Art. No.	Page	Art. No.	Page
tk 17920-01	7	tk 17923-15	9	tk 17928-03	11, 13
tk 17920-02	7	tk 17923-16	9, 14	tk 17928-04	11, 13
tk 17920-03	7	tk 17923-17	9	tk 17928-05	14
tk 17920-04	7	tk 17923-18	9	tk 17930-00	12
tk 17920-05	7, 12, 14	tk 17923-19	9	tk 17935-00	12
tk 17920-06	7	tk 17923-20	9	tk 17940-00	13
tk 17920-07	7, 12	tk 17923-21	9, 14	tk 17945-00	13
tk 17920-08	7	tk 17923-22	9	tk 17950-00	13
tk 17920-09	7	tk 17923-23	9, 13	tk 17955-00	14
tk 17920-10	7	tk 17923-24	9	tk 17960-00	14
tk 17920-11	7	tk 17923-25	9	tk 87015-04	15
tk 17920-12	7	tk 17923-26	9	tk 87020-00	15
tk 17920-13	7	tk 17924-01	9, 12	tk 87021-00	15
tk 17920-14	7, 13	tk 17924-02	9	tk 87023-03	15
tk 17920-15	7, 13, 14	tk 17924-03	9, 14	tk 87026-09	15
tk 17920-16	7	tk 17924-04	9	tk 87026-10	15
tk 17920-17	7	tk 17925-01	10	tk 87027-06	15
tk 17920-18	7	tk 17925-02	10, 12	tk 87100-2F-SI	15
tk 17920-19	12	tk 17925-03	10	tk 87110-2F-SI	15
tk 17921-01	7, 12, 14	tk 17925-04	10		
tk 17921-02	7, 12, 14	tk 17925-05	10, 14		
tk 17921-03	7	tk 17925-06	10, 13		
tk 17921-04	7, 14	tk 17925-07	10		
tk 17921-05	7, 12, 14	tk 17925-08	10, 13		
tk 17921-06	7, 12, 14	tk 17925-09	10		
tk 17921-07	8, 12	tk 17925-10	10, 13		
tk 17921-08	8, 12	tk 17925-11	10		
tk 17922-01	8	tk 17925-12	12		
tk 17922-02	8, 12, 14	tk 17925-13	12		
tk 17922-03	8, 12, 14	tk 17925-14	13		
tk 17922-04	8, 12	tk 17925-15	13		
tk 17922-05	8	tk 17925-16	13		
tk 17922-06	8, 12	tk 17925-17	13		
tk 17922-07	8	tk 17925-18	13		
tk 17922-08	8	tk 17925-19	13		
tk 17922-09	8	tk 17925-20	13		
tk 17922-10	8	tk 17926-01	10		
tk 17922-11	8	tk 17926-02	10		
tk 17922-12	8	tk 17926-03	10		
tk 17922-13	8	tk 17926-04	10		
tk 17922-14	8, 14	tk 17926-05	10		
tk 17922-15	8	tk 17926-06	10		
tk 17922-16	8	tk 17927-01	11, 12		
tk 17922-17	8	tk 17927-02	11		
tk 17922-18	8	tk 17927-03	11		
tk 17923-01	9, 12	tk 17927-04	11		
tk 17923-02	9, 12	tk 17927-05	11		
tk 17923-03	9, 12	tk 17927-06	11		
tk 17923-04	9, 13, 14	tk 17927-07	11		
tk 17923-05	9	tk 17927-08	11		
tk 17923-06	9, 13, 14	tk 17927-09	11		
tk 17923-07	9, 13	tk 17927-10	11		
tk 17923-08	9, 13	tk 17927-11	11		
tk 17923-09	9	tk 17927-12	11		
tk 17923-10	9	tk 17927-13	11		
tk 17923-11	9	tk 17927-14	11		
tk 17923-12	9	tk 17927-15	11		
tk 17923-13	9	tk 17928-01	11		
tk 17923-14	9, 14	tk 17928-02	11		

WICHTIGE HINWEISE:

Dieser Katalog bleibt Eigentum der Firma TEKNO-MEDICAL Optik-Chirurgie GmbH & Co. KG, auch wenn dafür eine Schutzgebühr bezahlt wurde. Er kann von uns jederzeit zurückgefordert werden, wenn er gegen unsere Interessen und nicht zum Vertrieb und Einkauf von TEKNO Produkten verwendet wird. Auch behalten wir uns in solch einem Falle weitergehende Maßnahmen vor.

Der Nachdruck oder Kopieren dieses Kataloges – im Gesamten oder auch nur auszugsweise – ist ohne unsere schriftliche Genehmigung verboten.

Modelländerungen vorbehalten.

IMPOTANT NOTICES:

This catalogue remains property of TEKNO-MEDICAL Optik-Chirurgie GmbH & Co. KG even if we have asked for a lending fee of charges. We can at any time recall the catalogue, in case that it has been not used according to our interests, i.e. sale or purchase of TEKNO products. We preserve the right for further steps in that case.

Reproduction or copying of this catalogue in whole or in parts is forbidden without our written permission.

Patterns are subject to change.

INDICATIONS IMPORTANTES:

Ce catalogue reste la propriété de TEKNO-MEDICAL Optik-Chirurgie GmbH & Co. KG, même si nous avons demandé le paiement d'une taxe de protection. Nous pouvons demander le retour du catalogue dans le cas où celui-ci n'est pas utilisé conformément à nos intérêts, pour la vente ou l'achat de nos produits. Dans ce cas nous nous réservons le droits de mener des actions juridiques.

La reproduction ou la copie totale ou partielle de ce catalogue est interdite sans notre accord écrit.

Sous réserve de modification techniques.

AVISOS IMPORTANTES:

Este catálogo es propiedad de TEKNO-MEDICAL Optik-Chirurgie GmbH & Co. KG, aún en el caso de haber abonado por él una tasa de colaboración. Podemos solicitar la devolución del catálogo en caso de que no sea utilizado para la compra o venta de nuestros productos. En este caso nos reservamos el derecho de tomar medidas judiciales.

La reproducción o copia total o parcial de este catálogo esta prohibido sin nuestro consentimiento escrito.

Salvo modificaciones técnicas.

AVVERTENZE IMPORTANTI:

Questo catalogo rimane proprietà della TEKNO-MEDICAL Optik-Chirurgie GmbH & Co. KG, anche se è stato rilasciato gratuitamente o contro pagamento. Possiamo in ogni momento richiederlo indietro, in caso non stato usato in accordo con i nostri interessi (acquisto e vendita dei prodotti TEKNO-Medical). Ci riserviamo in questo caso il diritto di prendere ulteriori provvedimenti.

La copia o la riproduzione di questo catalogo in parte o nella sua totalità è vietata senza il nostro permesso scritto.

Ci riserviamo la facoltà di cambiamenti nei modelli.



TEKNO-MEDICAL Optik-Chirurgie GmbH & Co. KG

Sattlerstraße 11 · 78532 Tuttlingen, Germany

Telefon +49 (74 61) 1701-0 · Fax +49 (74 61) 1701-50

mail@tekno-medical.com · www.tekno-medical.com

© 02.2007 - TEKNO-MEDICAL Optik-Chirurgie GmbH & Co. KG

TEKNO is a registered trademark of TEKNO-MEDICAL Optik-Chirurgie GmbH & Co. KG